



UNIVERSAL TAP'N GO



# Why choose **Speed&Go**

## Easy

ready-to-use nylon line disks

## Fast

line replacement in 10 seconds without tools

## Practical

line length is adjusted using the tap&go system

## Universal

the adapters kit makes the system compatible with any brushcutter on the market



# Speed&Go

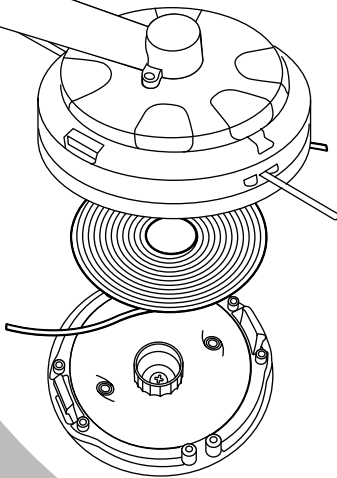
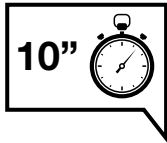

## ✓ Simple

The head can be refilled using a ready-to-use pre-wound line disk featuring easy opening without using tools

## ✓ Versatile

Thanks to the adapters kit the Speed&Go line head can be fitted to any brushcutter on the market

## ✓ Compact

130 mm diameter with low profile cap; each disk assures the maximum refill capacity in terms of line length

## ✓ Strong

Moulded fibreglass reinforced copolymer body for exceptional impact strength and wear resistance, even in the most demanding conditions

## ✓ Effective

Constantly perfect cutting performance thanks to the innovative nylon line cross section and material

# Speed & Go

How does it work? Just a few seconds,  
3 simple steps and it's done...



1

## Open with a click

by simply pressing the two side tabs - with no need for tools



2

## Fit the disk

on the aluminium plate and feed the two line ends through the eyelets



3

## Close

the head by realigning the two halves and gently pressing them together, & GO...



## Refilling the line

The innovative disk type **refilling system** is available in 2 sizes:

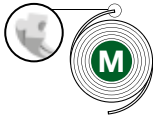

Ø 2.4 mm / .095"  
(7 m / 275" of line)

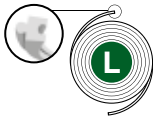

Ø 3.0 mm / .118"  
(5,5 m / 216" of line)

The exclusive cross **section** with the perfect combination of round/ square gives the following pluses:



**Aggressive cutting**

**Reduced vibration**









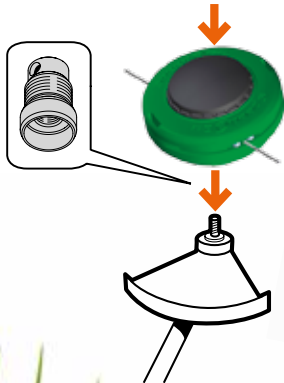

**Long life** thanks to the special blend of plastics employed and the patented production process

# Speed & Go

**Universal**  
thanks to the various adaptors available

The fixing system involves the use of **adaptors**, to be chosen on the basis of the brushcutter model. This technical solution ensures perfect centring between line head and bevel drive with clear benefits in terms of vibration reduction.



	M8x1,25LHF
	M10x1LHF
	M10x1,5LHF
	M12x1,25LHF
	M12x1,5LHF
	M10x1,25LHM
	M10x1,5LHM
	M7x1LHM
	3/8-24FLHF
	M12x1,75LHF
	M14x1,5LHF



It's an **Emak S.p.A.** trademark  
42011 Bagnolo in Piano (RE) Italy  
Tel. +39 0522 956611 • Fax +39 0522 951555  
[info@myoleomac.com](mailto:info@myoleomac.com) • [www.myoleomac.com](http://www.myoleomac.com)  
[YouTube www.youtube.com/MyOleoMac](http://www.youtube.com/MyOleoMac)



00000000